

DPM 702S

3½ Digit Dual Channel LCD Module

No.:695 - Page 1 of 2

An ultra-low profile LCD meter using advanced components and construction techniques to provide an unrivaled combination of dual channel voltage measurements and low cost. This product is ideal for those applications where "matched" readings are required, e.g.: voltage and current, temperature and humidity, etc. Both measurement inputs share a common ground line, thereby reducing the number of connections to a minimum. The very low current consumption results in a long battery life and makes it especially suitable for portable equipment. A low battery warning circuit is fitted as standard. The 10-way pin header can be replaced by screw terminal blocks on request. Contact your nearest Lascar Sales Office for further details.

- 🌀 6.4mm (0.25") Digit Height
- 🌀 Dual Channel
- 🌀 200mV d.c. Full Scale Reading (F.S.R.)
- 🌀 Selectable Decimal Points
- 🌀 Auto-zero, Auto-polarity
- 🌀 Common Signal Ground
- 🌀 Annunciators

SCALING

The full scale reading (F.S.R.) of each measurement channel may be altered by the addition of two resistors Ra and Rb per channel- see table. Each measurement channel will require re-calibration by adjusting CAL A and CAL B.

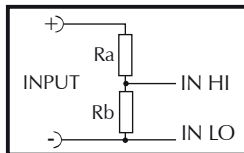

Required F.S.R.	Ra	Rb
2V	910k	100k
20V	1M	10k
200V	1M	1k
2kV	1M	100R
200µA	0R	1k
2mA	0R	100R
20mA	0R	10R
200mA	0R	1R

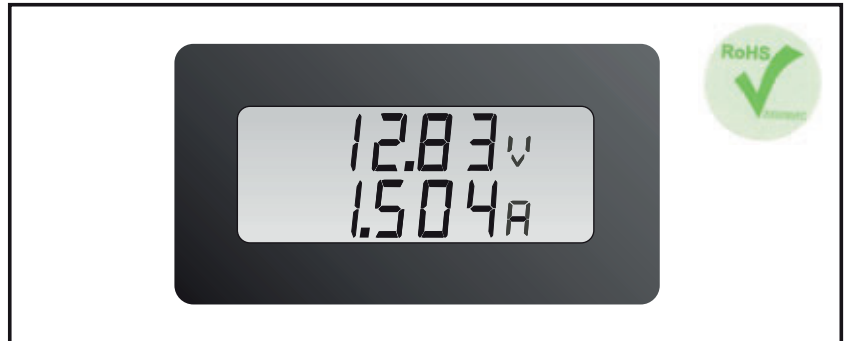

Dual Channel Meter				Stock Number
				DPM 702S
Specification (channel A or B)	Min.	Typ.	Max.	Unit
Accuracy (overall error)*		0.05	0.1	% (±1 count)
Linearity			±1	count
Full scale reading	-199.9		199.9	mV d.c.
Resolution		100		µV d.c.
Sample rate		3		samples/sec
Operating temperature range	0		50	°C
Temperature stability		100		ppm/°C
Supply voltage	3.5	5	7	V d.c.
Supply current		700		µA
Input leakage current (Vin= 0V)		1	10	pA

* To ensure maximum accuracy, re-calibrate periodically.

DIMENSIONS All dimensions in mm (inches)

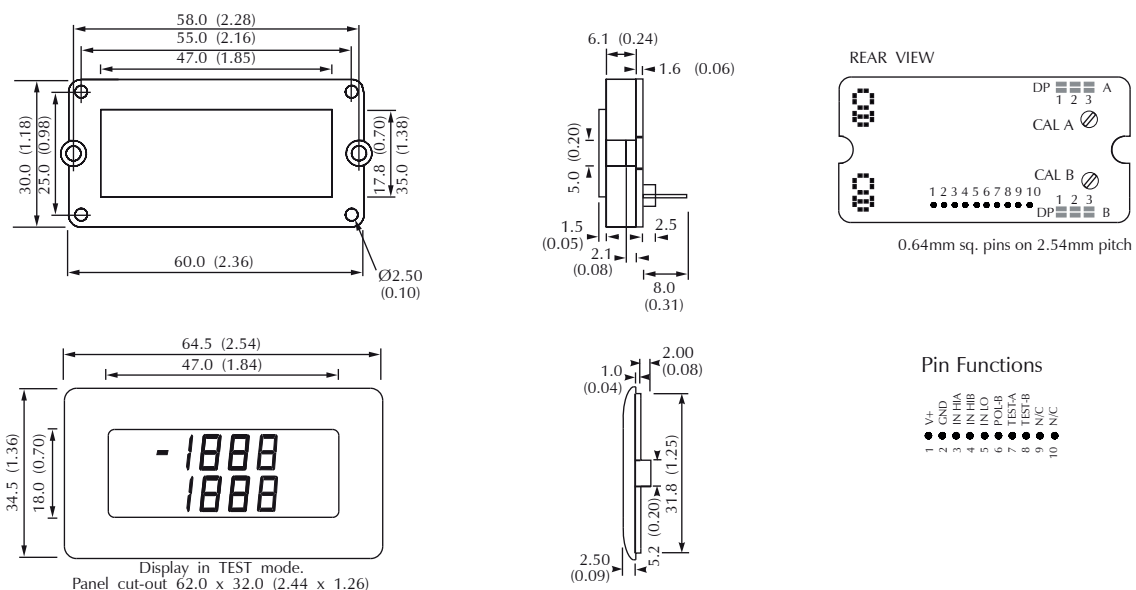

PANEL FITTING

Fit the bezel to the front of the panel, then locate the meter to the bezel from behind the panel. Using the screws provided, secure the two plastic spring clips to the rear of the meter. The meter is designed to fit directly onto OKW Type M, P and Veronex size 3 enclosures.

PIN FUNCTIONS

- | | | |
|-----------|------------------------------------------------------------------------------------------------------------------------------------|---------------------------------------------------------------------|
| 1. V+ | Positive power supply connection. | |
| 2. GND | 0V supply connection. | |
| 3. IN HIA | Positive measuring differential input. | } Analogue inputs must be no closer than 1V to the positive supply. |
| 4. IN HIB | Positive measuring differential input. | |
| 5. IN LO | Negative measuring differential input. | |
| 6. POL-B | Drive pin for channel B polarity sign.
Connect to V+ to invert polarity sign when measuring Voltage and Current simultaneously. | |
| 7. TEST-A | Connect to V+ to display all Channel A segments, except annunciators. | |
| 8. TEST-B | Connect to V+ to display all Channel B segments, except annunciators. | |
| 9. N/C | Not connected. | |
| 10. N/C | Not connected. | |

SAFETY

To comply with the Low Voltage Directive (LVD 93/68/EEC), input voltages to the module's pins must not exceed 60Vdc. If voltages to the measuring inputs do exceed 60Vdc, then fit scaling resistors externally to the module. The user must ensure that the incorporation of the DPM into the user's equipment conforms to the relevant sections of BS EN 61010 (Safety Requirements for Electrical Equipment for Measuring, Control and Laboratory Use).

DISPLAYING ANNUNCIATORS

Annunciators are displayed by making the required solder links. See below for examples.

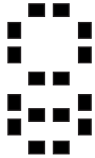

Blank

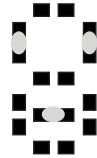

V

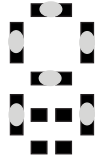

A



Decimal Point 1 enabled.



Decimal Point 2 enabled.



Decimal Point 3 enabled.

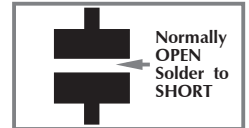

VARIOUS OPERATING MODES

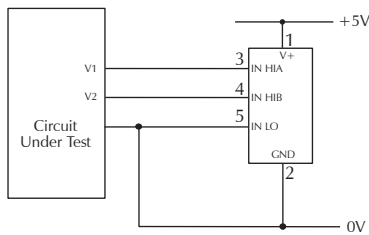

Measuring Two d.c. Voltages

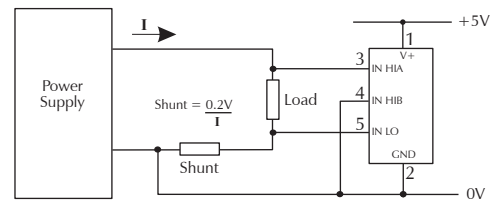

Simultaneous d.c. Voltage and Current Measurement.
 Invert the polarity sign of channel B by connection pin 6 to pin 1.

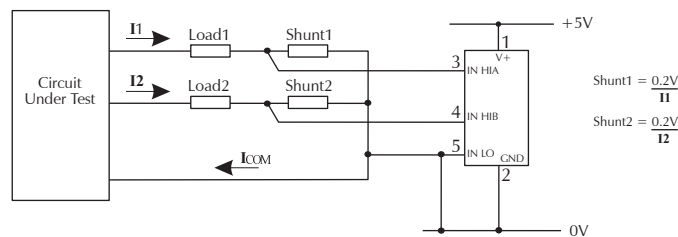

Measuring Two d.c. Currents.